



# **DIGITUS**® Network & Server Cabinets

---

# **DYNAMIC BASIC Series**



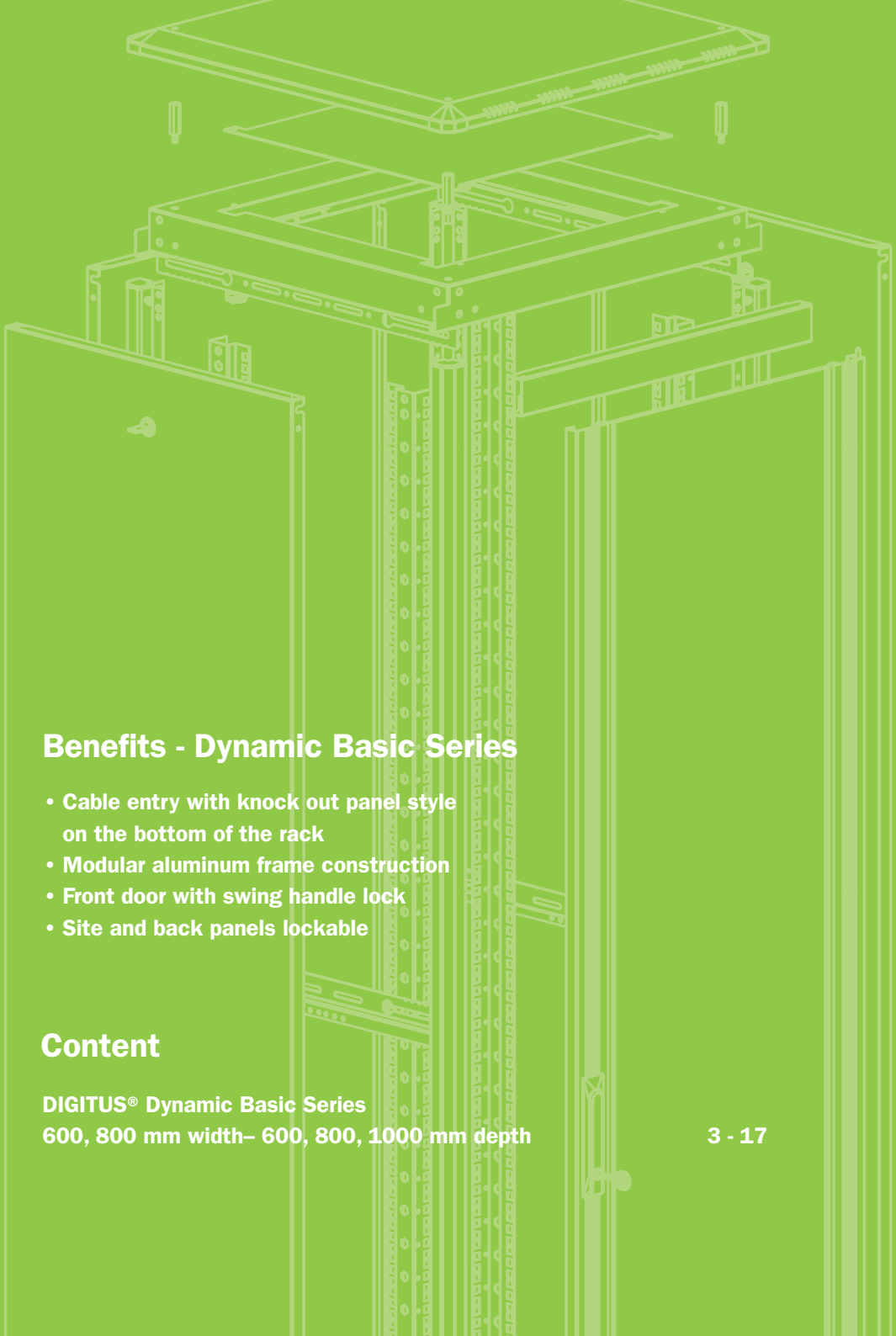

## Benefits - Dynamic Basic Series

- Cable entry with knock out panel style on the bottom of the rack
- Modular aluminum frame construction
- Front door with swing handle lock
- Site and back panels lockable

## Content

DIGITUS® Dynamic Basic Series  
600, 800 mm width– 600, 800, 1000 mm depth

## DIGITUS® Network- and Server Cabinet Dynamic Basic Series



✓ 15 Years Product Warranty

✓ 600 kg loading capacity

✓ Large range of equipment available

### Abstract

DIGITUS® Dynamic Basic Series – 600, 800 mm width– 600, 800, 1000 mm depth

### Features

- IP20 rating
- Steel front door with 4,00mm safety glass and swing handle lock
- Side- and back panel lockable
- EMKA closing system
- 120° opening door angle
- Door hanging can reversed left to right
- Modular aluminium frame construction
- High frame rigidity due to special plate-curving-technique
- Steel plate 1.5mm
- 600 kg loading capacity
- 19" profile rails mounted in the front and the back of the cabinet
- 19" profile rails adjustable in depth
- 19" profile rails with unit-marking
- 19" profile rails with 8-12 micron zinc plating for corrosion resistance
- Big cable entry with knock out panel style on the bottom
- Adjustable feet for positioning
- Top case ready for fan units
- 2 keys for door and side panels included
- Available in grey color RAL7035 and black color RAL9005
- Several earthing points for mounting components
- Delivery occur completely mounted
- Large range of equipment available

## DIGITUS® Network- and Server Cabinet Dynamic Basic Series

### Product Overview

The **DIGITUS® Dynamic Basic Series** is designed and produced for the high requirements of the IT-Infrastructure. The **DIGITUS® Network- and Server Cabinet Dynamic Basic Series** is developed and produced for cabling and network components. They provide maximum optimization resulted to an optimum performance in between quality and added value. Each cabinet is designed with strength, ease of use and aesthetics in mind.

Features, such as 1 unit marking on the mounting profiles, easy and quick release of the door and side- and rear panels, fully adjustable front and rear profiles of the cabinet in depth, makes the product extremely attractive to installers. The incredible design of the **Dynamic Basic Series** is rounded up with the use of a framed smoked safety glass front door fitted with a swing handle lock. Door hinging can be quickly reversed left to right.

The **Dynamic Basic Series** is available in different heights from 22 units up to 42 units. A various size of 600mm, 800mm and 1000mm depth are in the portfolio of the **Dynamic Basic Series**. Each cabinet includes a lockable glass front door and lockable steel back- and side panels. 2 sets of adjustable mounting profiles and a cable entry at the bottom are equipped. Furthermore the roof is prepared for fan trays. A huge range of **DIGITUS®** accessories are available to customize the cabinet due to the needs of the end-user.

### Product Information Network Cabinet Dynamic Basic Series 600 mm width x 600 mm depth

DN-19 22U-6/6-D DIGITUS® 22U network cabinet 1121x600x600, grey RAL7035  
DN-19 26U-6/6-D DIGITUS® 26U network cabinet 1299x600x600, grey RAL7035  
DN-19 32U-6/6-D DIGITUS® 32U network cabinet 1566x600x600, grey RAL7035  
DN-19 42U-6/6-D DIGITUS® 42U network cabinet 2010x600x600, grey RAL7035

### Product Information Network Cabinet Dynamic Basic Series 600 mm width x 800 mm depth

DN-19 22U-6/8-D DIGITUS® 22U network cabinet 1121x600x800, grey RAL7035  
DN-19 26U-6/8-D DIGITUS® 26U network cabinet 1299x600x800, grey RAL7035  
DN-19 32U-6/8-D DIGITUS® 32U network cabinet 1566x600x800, grey RAL7035  
DN-19 42U-6/8-D DIGITUS® 42U network cabinet 2010x600x800, grey RAL7035

### Product Information Network Cabinet Dynamic Basic Series 800 mm width x 800 mm depth

DN-19 32U-8/8-D DIGITUS® 32U network cabinet 1566x800x800, grey RAL7035  
DN-19 42U-8/8-D DIGITUS® 42U network cabinet 2010x800x800, grey RAL7035

## **DIGITUS<sup>®</sup> Network- and Server Cabinet Dynamic Basic Series**

### **Product Information Server Cabinet Dynamic Basic Series 600 mm width x 1000 mm depth**

DN-19 SRV-26U-D DIGITUS<sup>®</sup> 26U server cabinet 1299x600x1000, grey RAL7035

DN-19 SRV-42U-D DIGITUS<sup>®</sup> 42U server cabinet 2010x600x1000, grey RAL7035

### **Product Information Server Cabinet Dynamic Basic Series 800 mm width x 1000 mm depth**

DN-19 SRV-42U-8-D DIGITUS<sup>®</sup> 42U server cabinet 2010x800x1000, grey RAL7035

### **Conform due to standards**

ISO 9001:2008	Quality management system
EN 61587-1:2012	Mechanical carrier for electric systems
EN 60950-1:2006	CE information technological systems- safety- Part1 – general requirements
IEC 297-1	19"Unit
IEC 297-2	Metric unit

## DIGITUS® Network- and Server Cabinet Dynamic Basic Series

### 19" DIGITUS® Dynamic Basic Network Cabinet I 600mm width x 600mm depth

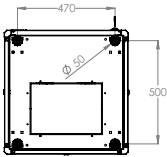

BOTTOM VIEW

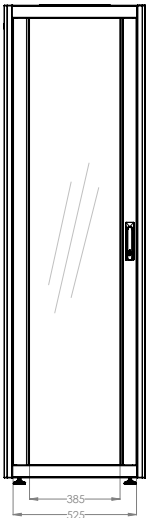

FRONT VIEW

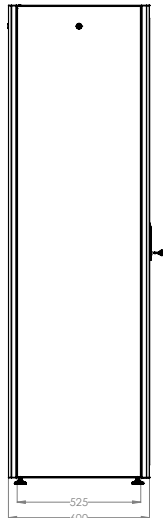

SIDE VIEW

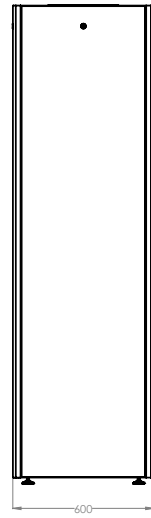

REAR VIEW

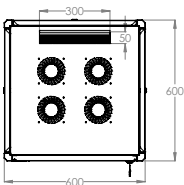

TOP VIEW

**DIGITUS® Network- and Server Cabinet  
Dynamic Basic Series**

**19" DIGITUS® Dynamic Basic Network Cabinet | 600mm width x 600mm depth**

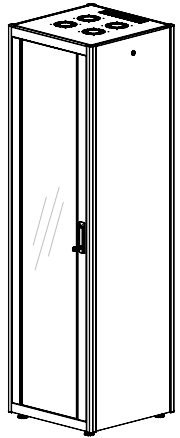

ISOMETRIC VIEW

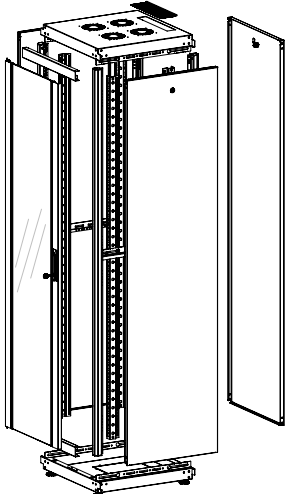

EXPLODED VIEW

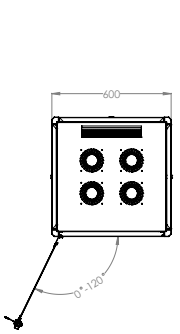

FRONT DOOR  
OPENING ANGLE

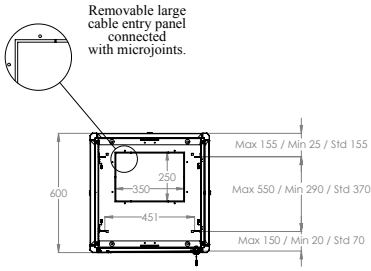

MAX/STD/MIN  
EQUIPMENT MOUNTING  
DISTANCE

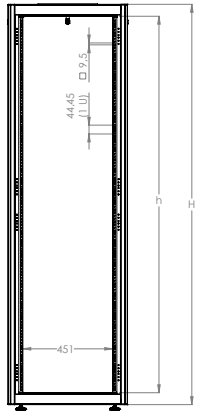

DIMENSIONS  
IN  
WIDTH AND HEIGHT

## DIGITUS® Network- and Server Cabinet Dynamic Basic Series

### 19" DIGITUS® Dynamic Basic Network Cabinet I 600mm width x 800mm depth

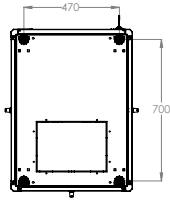

BOTTOM VIEW

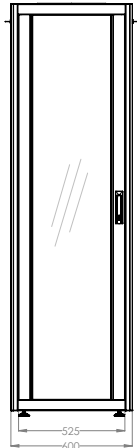

FRONT VIEW

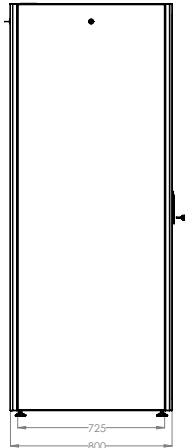

SIDE VIEW

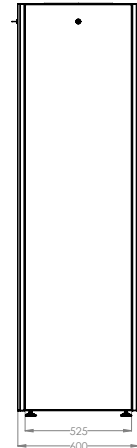

REAR VIEW

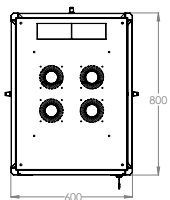

TOP VIEW



**DIGITUS® Network- and Server Cabinet  
Dynamic Basic Series**

**19" DIGITUS® Dynamic Basic Network Cabinet | 600mm width x 800mm depth**

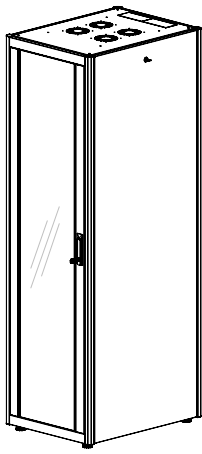

ISOMETRIC VIEW

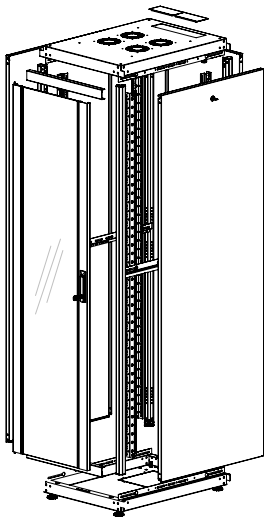

EXPLODED VIEW

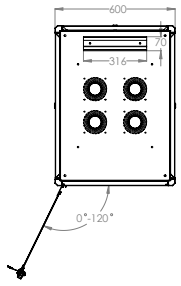

FRONT DOOR  
OPENING ANGLE

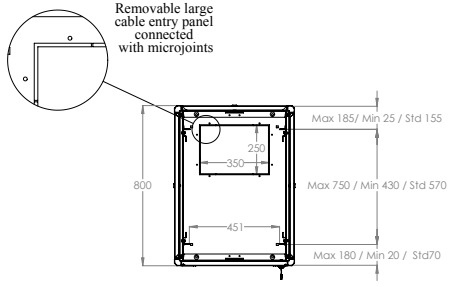

MAX / STD / MIN  
EQUIPMENT  
MOUNTING  
DISTANCE

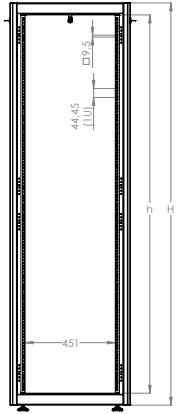

DIMENSIONS  
IN  
WIDTH AND HEIGHT

**DIGITUS® Network- and Server Cabinet  
Dynamic Basic Series**

**19" DIGITUS® Dynamic Basic Network Cabinet I 800mm width x 800mm depth**

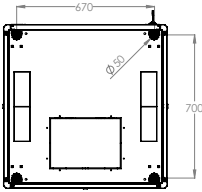

**BOTTOM VIEW**

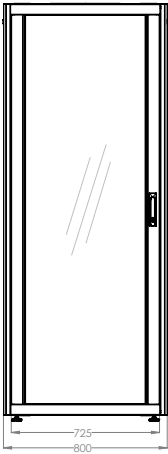

**FRONT VIEW**

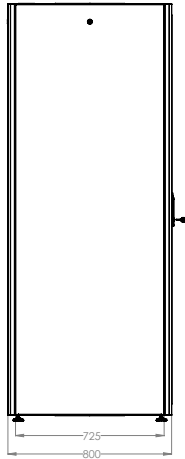

**SIDE VIEW**

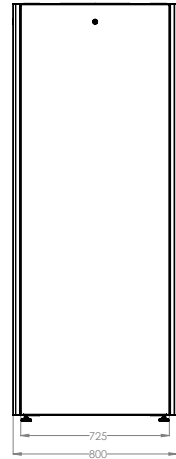

**REAR VIEW**

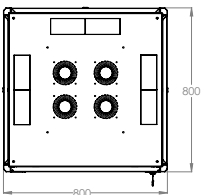

**TOP VIEW**

**DIGITUS® Network- and Server Cabinet  
Dynamic Basic Series**

**19" DIGITUS® Dynamic Basic Network Cabinet | 800mm width x 800mm depth**

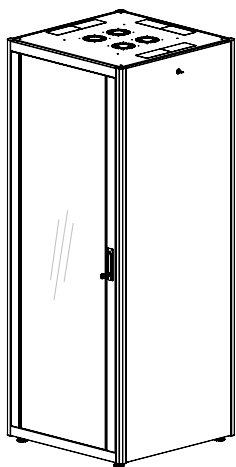

ISOMETRIC VIEW

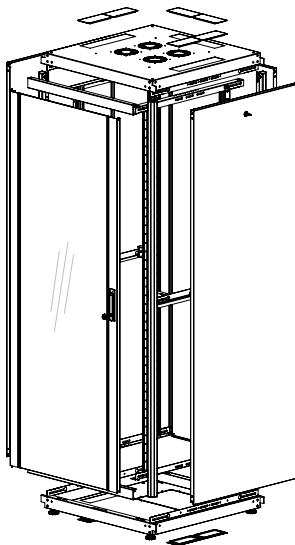

EXPLODED VIEW

Removable large cable entry panel connected with microjoints.

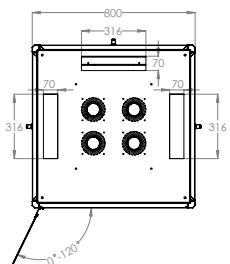

FRONT DOOR  
OPENING ANGLE

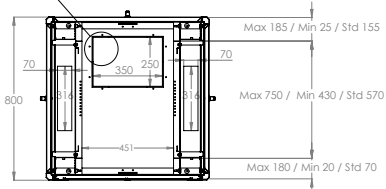

MAX/STD/MIN  
EQUIPMENT MOUNTING  
DISTANCE

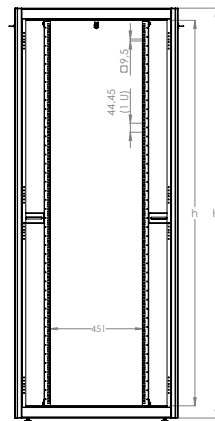

DIMENSIONS  
IN  
WIDTH AND HEIGHT

## DIGITUS<sup>®</sup> Network- and Server Cabinet Dynamic Basic Series

### 19" DIGITUS<sup>®</sup> Dynamic Basic Server Cabinet | 600mm width x 1000mm depth

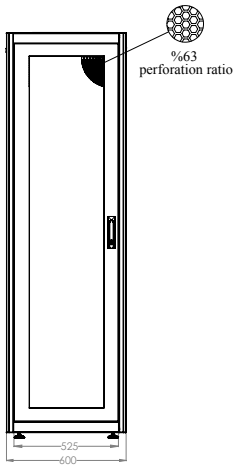
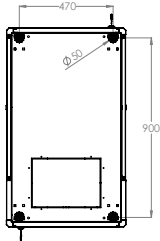

FRONT VIEW

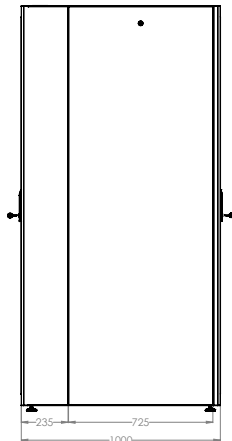

SIDE VIEW

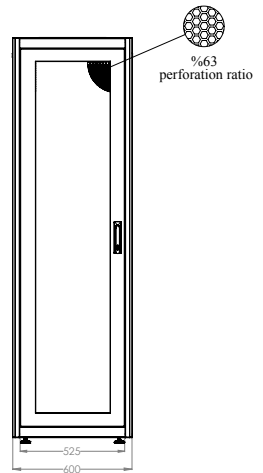

REAR VIEW

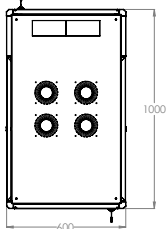

TOP VIEW

# DIGITUS® Network- and Server Cabinet Dynamic Basic Series

## 19" DIGITUS® Dynamic Basic Server Cabinet I 600mm width x 1000mm depth

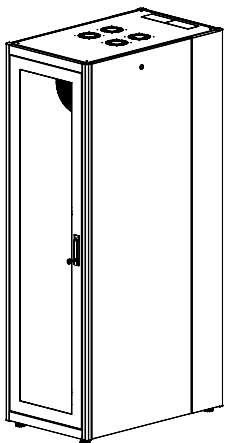

ISOMETRIC VIEW

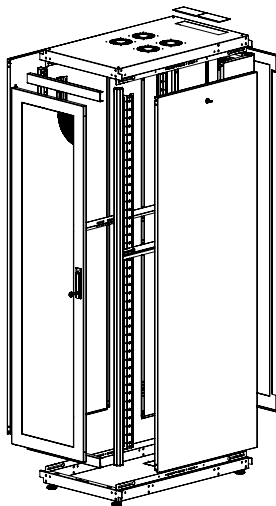

EXPLODED VIEW

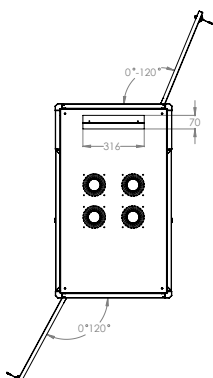

FRONT AND REAR  
DOOR  
OPENING ANGLE

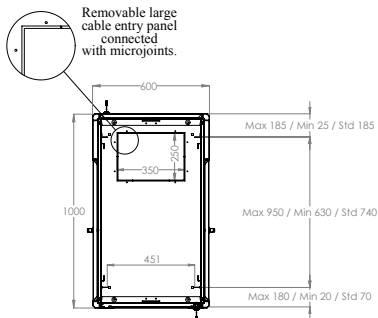

MAX/STD/MIN  
EQUIPMENT MOUNTING  
DISTANCE

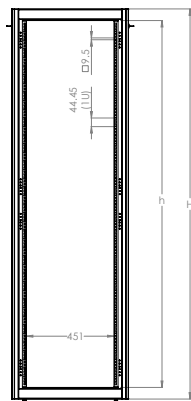

DIMENSIONS  
IN  
WIDTH AND HEIGHT

**DIGITUS<sup>®</sup> Network- and Server Cabinet**  
**Dynamic Basic Series**

**19" DIGITUS<sup>®</sup> Dynamic Basic Server Cabinet I 800mm width x 1000mm depth**

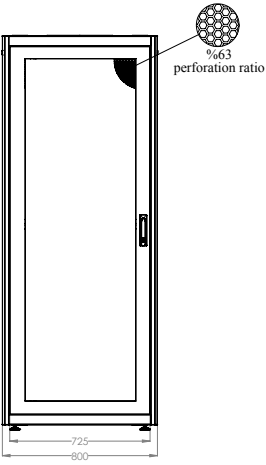
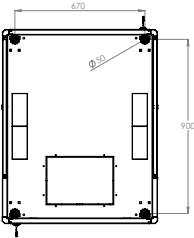

FRONT VIEW

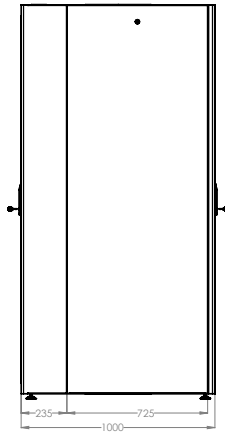

SIDE VIEW

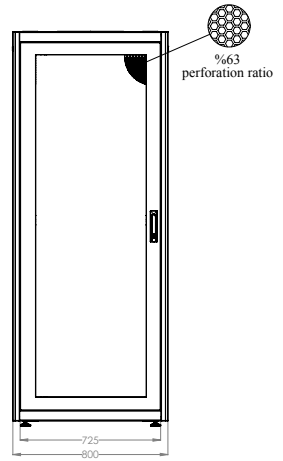

REAR VIEW

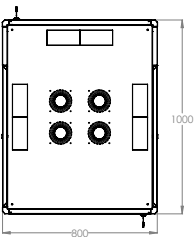

TOP VIEW

**DIGITUS® Network- and Server Cabinet  
Dynamic Basic Series**

**19" DIGITUS® Dynamic Basic Server Cabinet | 800mm width x 1000mm depth**

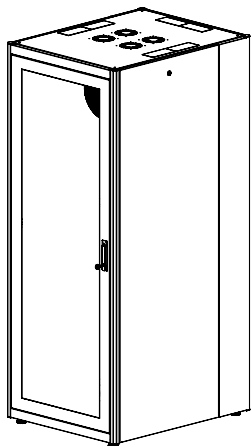

ISOMETRIC VIEW

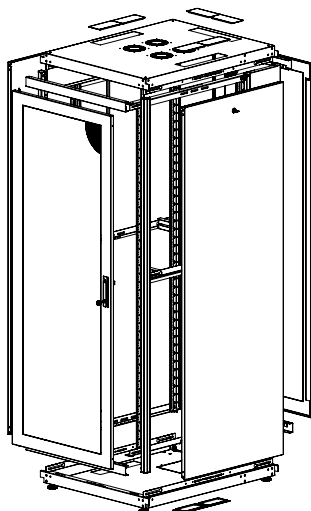

EXPLODED VIEW

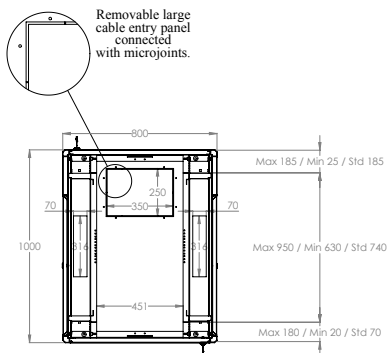
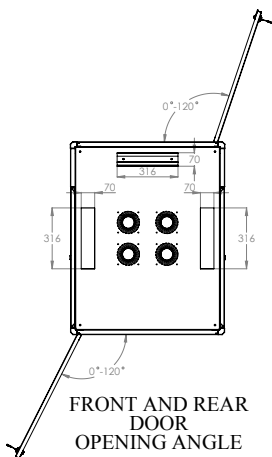

MAX/STD/MIN  
EQUIPMENT MOUNTING  
DISTANCE

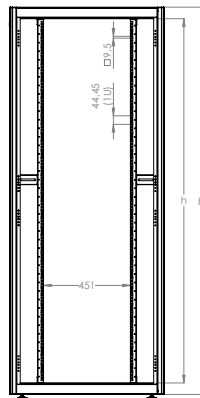

DIMENSIONS  
IN  
WIDTH AND HEIGHT

## **DIGITUS® Network- and Server Cabinet Dynamic Basic Series**

### **Detailed Product Images**





## DIGITUS® Network- and Server Cabinet Dynamic Basic Series

### Detailed Product Images



DIGITUS® is made for high demand IT-Infrastructure Solutions – designed and developed on highest standard in Germany.

